

**CARATTERISTICHE COSTRUTTIVE / CONSTRUCTION FEATURES
CARACTERÍSTICAS CONSTRUCTIVAS / CARACTÉRISTIQUES D'EXÉCUTION**

Corpo pompa Pump body Cuerpo bomba Corps de pompe	acciaio cromo-nickel AISI 304 stainless steel AISI 304 acero cromo-níquel AISI 304 acier chrome-nickel AISI 304
Supporto motore Motor bracket Soporte motor Support moteur	alluminio aluminium aluminio aluminium
Giranti, diffusori Impellers, diffusers Rodetes, difusores Turbines, diffuseurs	acciaio cromo-nickel AISI 304 stainless steel AISI 304 acero cromo-níquel AISI 304 acier chrome-nickel AISI 304
Tenuta meccanica Mechanical seal Sello mecánico Gamiture mécanique	ceramica-grafite ≤ 6 giranti grafite-carburo di silicio ≥ 7 giranti ceramic-graphite ≤ 6 impellers graphite-silicon carbide ≥ 7 impellers cerámica-grafito ≤ 6 rodetes grafito-carburo de silicio ≥ 7 rodetes céramique-graphite ≤ 6 turbines graphite-carbure de silicium ≥ 7 turbines
Albero motore Motor shaft Eje motor Arbre moteur	acciaio cromo-nickel AISI 303 stainless steel AISI 303 acero cromo-níquel AISI 303 acier chrome-nickel AISI 303
Temperatura del liquido Liquid temperature Temperatura del líquido Température du liquide	-15 ÷ +110 °C
Pressione di esercizio Operating pressure Presión de trabajo Pression de fonctionnement	max 8,5 bar
MOTORE / MOTOR / MOTOR / MOTEUR	
Motore 2 poli a induzione 2 pole induction motor Motor de 2 polos a inducción Moteur à induction à 2 pôles	3~ 230/400V-50Hz 1~ 230V-50Hz (con termoprotettore fino a 1,85kW with thermal protection up to 1,85 kW con protección térmica hasta 1,85 kW avec protection thermique jusqu'à 1,85 kW)
Classe di isolamento Insulation class Clase de aislamiento Classe d'isolation Grado di protezione Protection degree Grado de protección Protection	F IP44

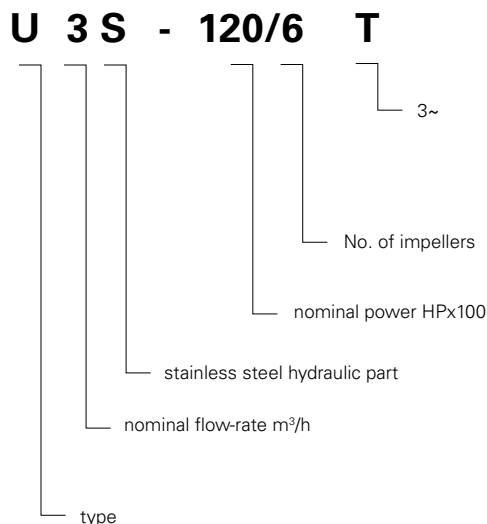

ULTRA 3S



ULTRA 5S



ULTRA 7S



ULTRA 9S



ULTRA 18S



Pompe centrifughe multistadio orizzontali. Adatte alla movimentazione di liquidi non carichi; sistemi di pressurizzazione; irrigazione; acque potabili o con glicole in soluzione; trattamento acque; industria alimentare; riscaldamento e condizionamento; sistemi di lavaggio.

Stainless steel multistage horizontal pumps. Pumping of clean non-loaded fluids; pressurizing system; irrigation; drinking and glycol water; water treatment; heating and air conditioning; washing system.

Bombas centrifugas multietapas horizontales. Bombeo de líquidos químicamente y mecánicamente no agresivos; sistemas de presurización; riego; agua potable o con glicol; tratamientos del agua; industria alimenticia; calefacción y refrigeración; sistemas de lavado.

Pompes centrifuges multicellulaires horizontales. Pompage d'eaux propres non chargées; groupes de surpression; irrigation; eau potable ou solution de glycol; traitement des eaux; industrie alimentaire; chauffage et climatisation; stations de lavage auto.

ULTRA S

3 S

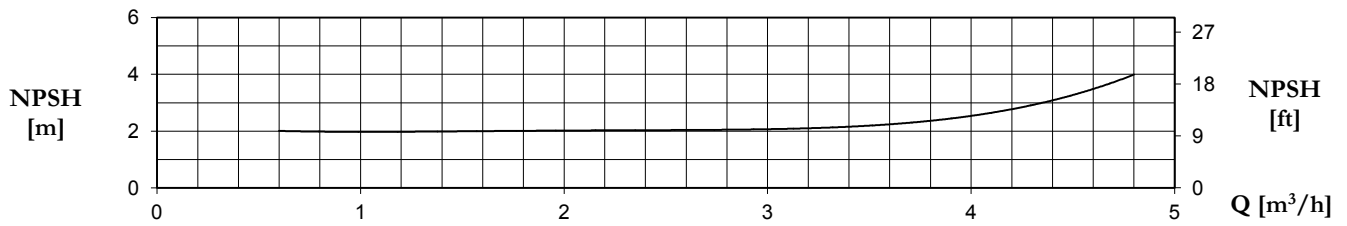
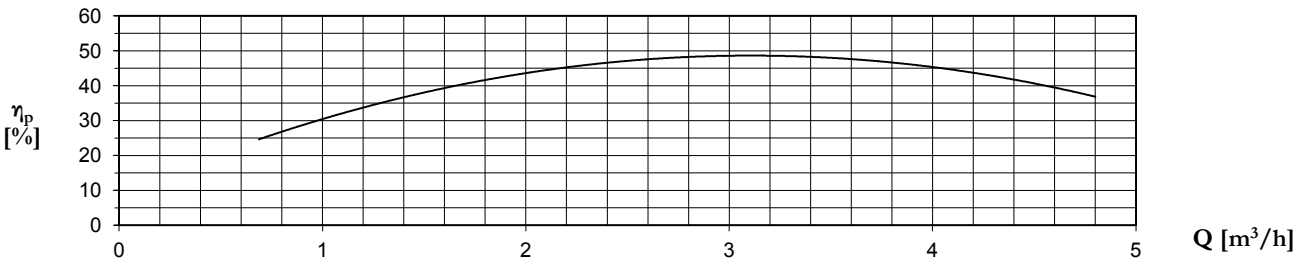
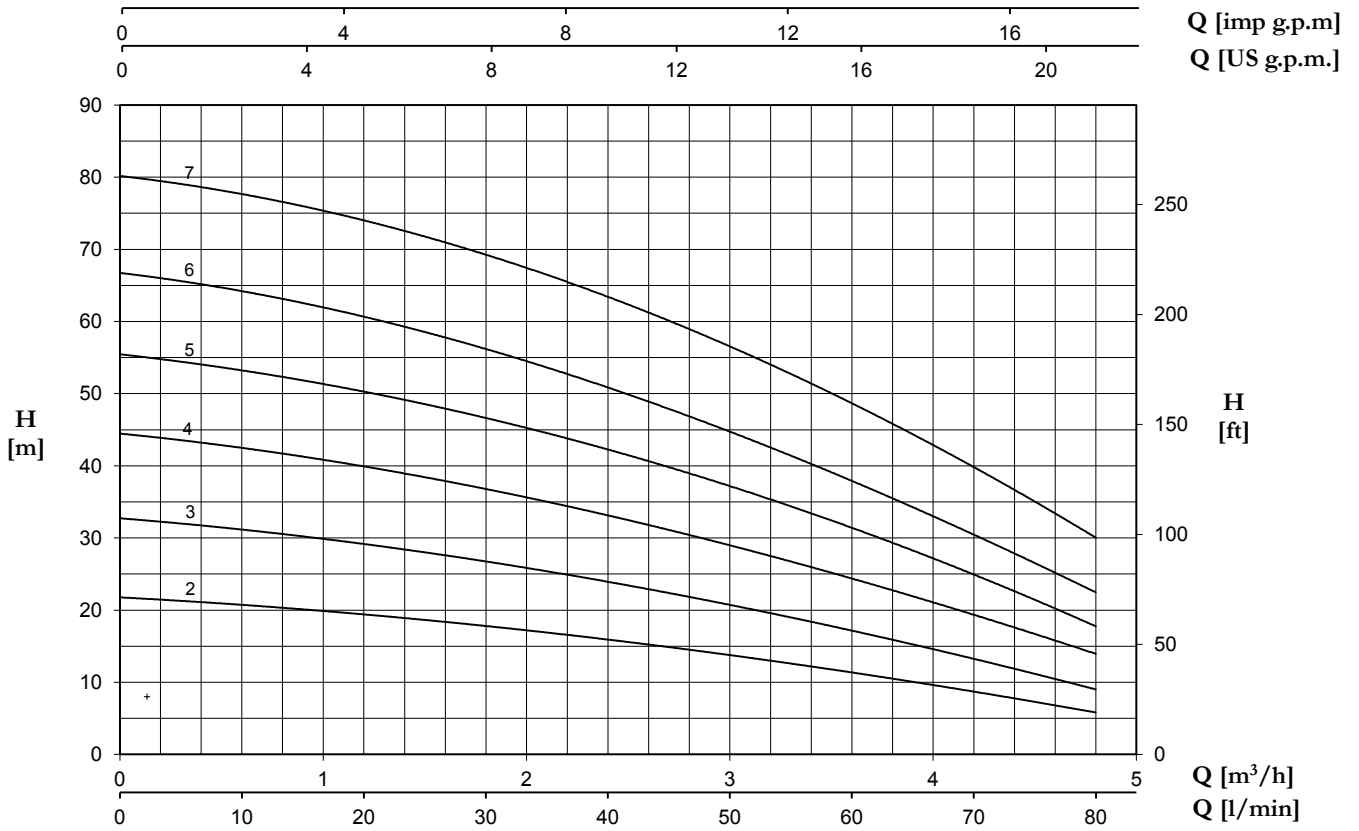

TYPE		P2		P1 (kW)		AMPERE		Q (m³/h - l/min)						
1~	3~					1~	3~	0	0,6	1,2	1,8	2,4	3,6	4,8
		(HP)	(kW)	1~	3~	1x230 V 50 Hz	3x400 V 50 Hz	H (m)						
U 3S-50/2	U 3S-50/2T	0,5	0,37	0,41	0,41	1,8	0,9	21,7	20,9	19,3	17,8	15,9	11,4	5,8
U 3S-70/3	U 3S-70/3T	0,7	0,51	0,61	0,58	2,7	1,1	32,7	31,2	29,2	26,7	23,9	17,2	9
U 3S-90/4	U 3S-90/4T	0,9	0,66	0,83	0,8	3,6	1,7	44,3	42,8	40	36,4	33,2	24,5	13,9
U 3S-100/5	U 3S-100/5T	1	0,75	0,99	0,92	4,4	1,7	55,3	53,5	50,3	46,5	42,1	31,6	17,7
U 3S-120/6	U 3S-120/6T	1,2	0,9	1,11	1,11	5,1	2,5	66,6	64,4	60,8	56	50,7	38,1	22,4
U 3S-150/7	U 3S-150/7T	1,5	1,1	1,38	1,31	6,4	2,7	80,1	77,7	74,2	69,1	63,3	48,8	30

5 S

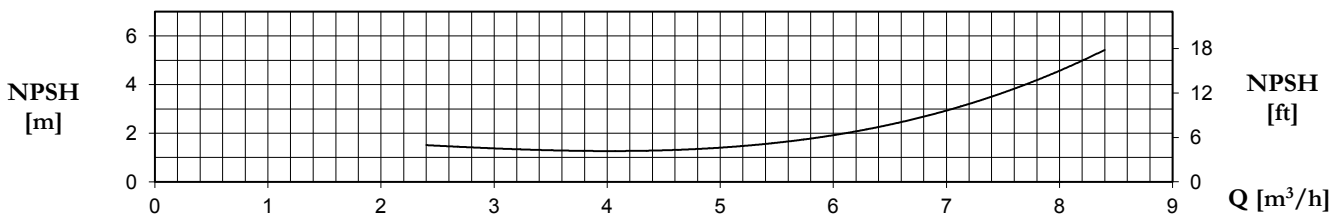
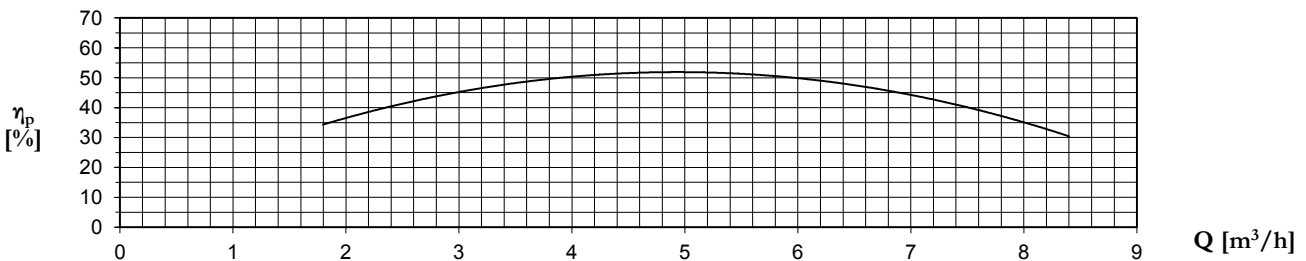
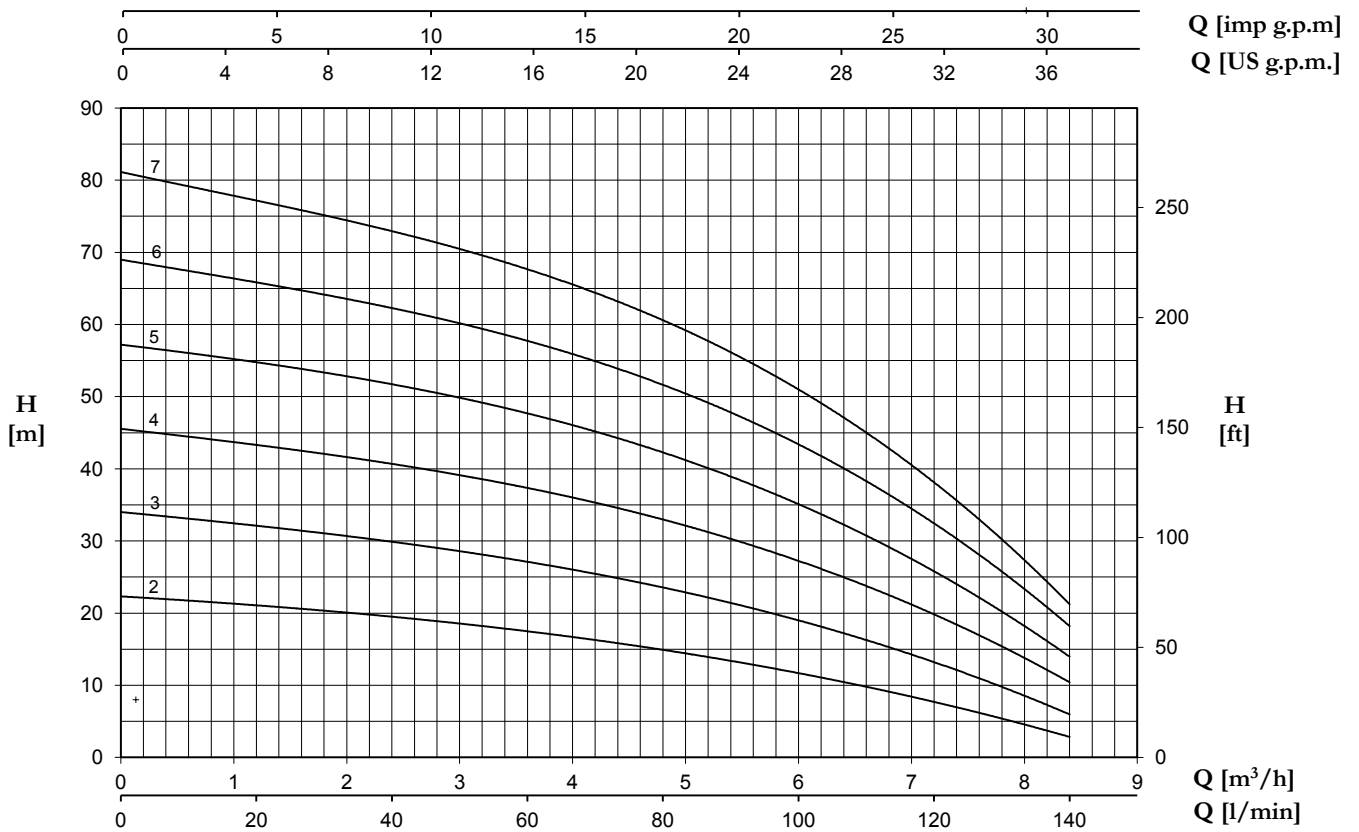

TYPE		P2		P1 (kW)		AMPERE		Q (m³/h - l/min)							
1~	3~					1~	3~	0	1,8	2,4	3,6	4,8	6	7,2	8,4
		(HP)	(kW)	1~	3~	1x230 V 50 Hz	3x400 V 50 Hz	H (m)							
U 5S-70/2	U 5S-70/2T	0,7	0,51	0,6	0,58	2,6	1,1	22,3	20,4	19,5	17,5	14,8	11,7	7,8	2,8
U 5S-80/3	U 5S-80/3T	0,8	0,6	0,8	0,75	3,8	1,4	34	31,1	29,9	27	23,6	19,1	13,1	6
U 5S-120/4	U 5S-120/4T	1,2	0,9	1,09	1,08	4,9	2,4	45,5	42,2	40,7	37,2	32,9	27,4	19,8	10,4
U 5S-150/5	U 5S-150/5T	1,5	1,1	1,39	1,31	6,5	2,7	57,2	53,4	51,7	47,6	42,3	35,2	25,7	14
U 5S-180/6	U 5S-180/6T	1,8	1,3	1,63	1,55	7,3	3	68,9	64,4	62,3	57,5	51,5	43,5	32,6	18,1
U 5S-200/7	U 5S-200/7T	2	1,5	1,94	1,77	8,7	3,3	81	75,5	73	67,4	60,3	51	38,6	21

ULTRA S

7 S

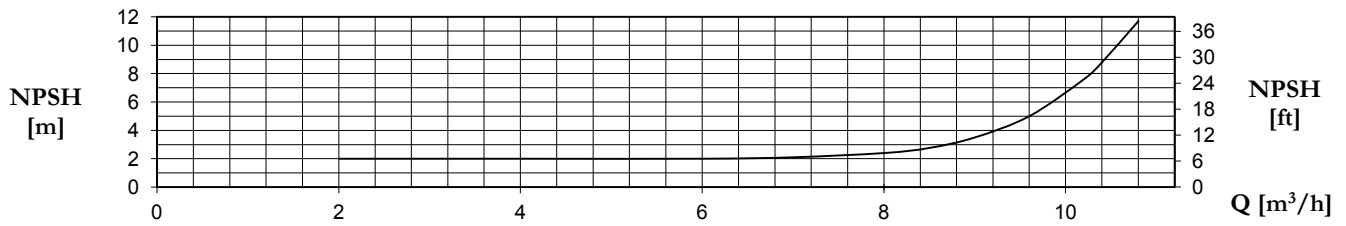
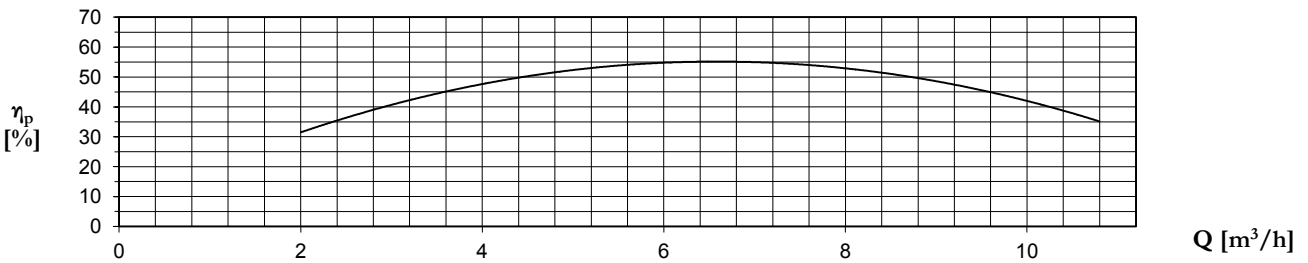
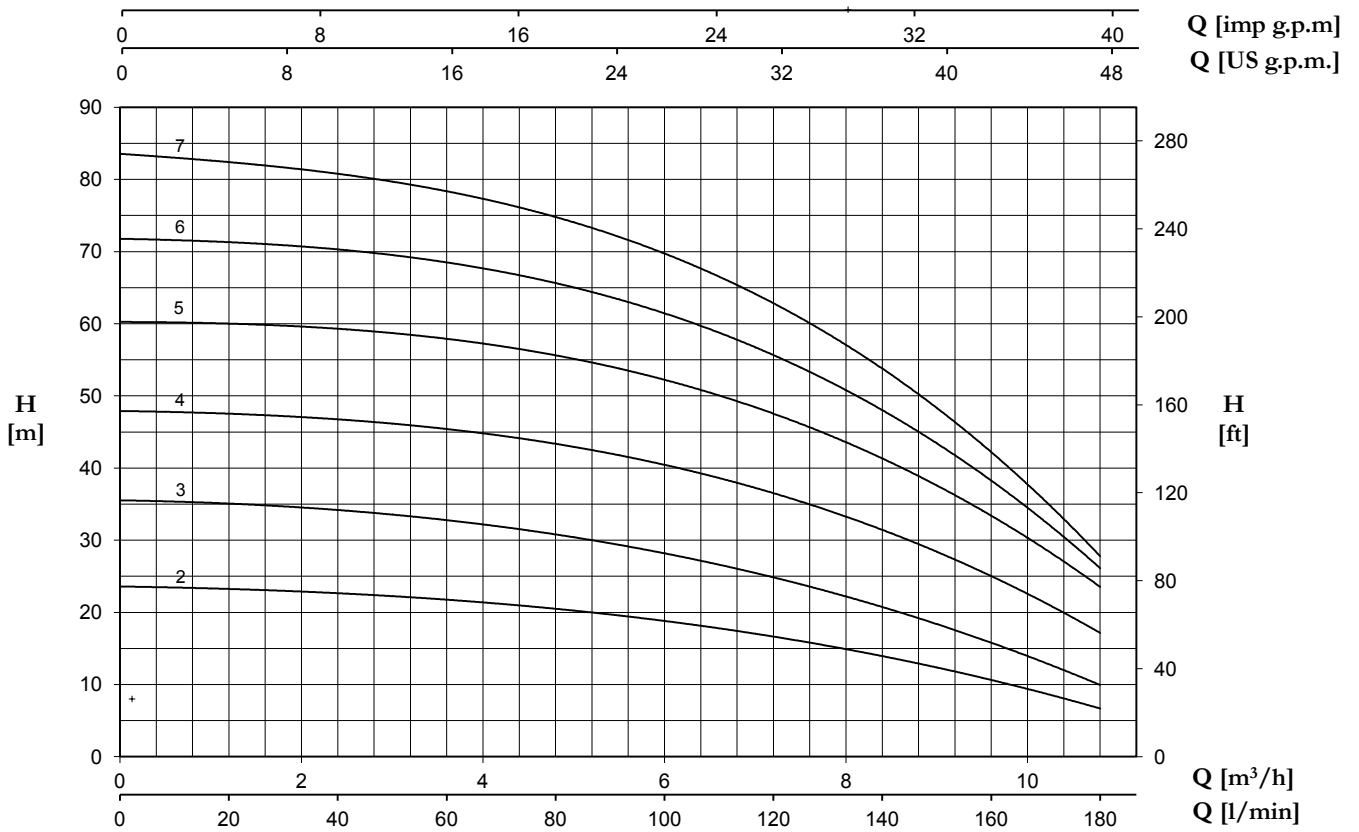

TYPE		P2		P1 (kW)		AMPERE		Q (m³/h - l/min)								
1~	3~					1~	3~	0	2,4	3,6	4,8	6	7,2	8,4	9,6	10,8
		(HP)	(kW)	1~	3~	1x230 V 50 Hz	3x400 V 50 Hz	H (m)								
U 7S-100/2	U 7S100/2T	1	0,75	0,91	0,84	4,1	1,6	23,6	22,6	21,8	20,5	18,8	16,7	13,9	10,6	6,7
U 7S-120/3	U 7S-120/3T	1,2	0,9	1,23	1,22	5,6	2,5	35,6	33,9	32,8	31,2	28,1	24,7	20,8	15,7	10
U 7S-180/4	U 7S-180/4T	1,8	1,3	1,69	1,62	7,7	3,1	48	46,3	45,7	43,6	40,4	36,4	31,4	25	17,2
U 7S-250/5	U 7S-250/5T	2,5	1,85	2,19	2,05	10,2	4,1	60,3	59	58,2	55,7	52,2	47,4	41,3	33,5	22
U 7S-300/6	U 7S-300/6T	3	2,2	2,53	2,44	11,4	4,8	72,5	70,5	69,2	66	61,5	55,7	47,8	37,8	24,7
-	U 7S-350/7T	3,5	2,57	-	2,84	-	5,1	83,5	80,7	78,8	74,7	69,4	62,6	53,9	42,7	27,5

9 S

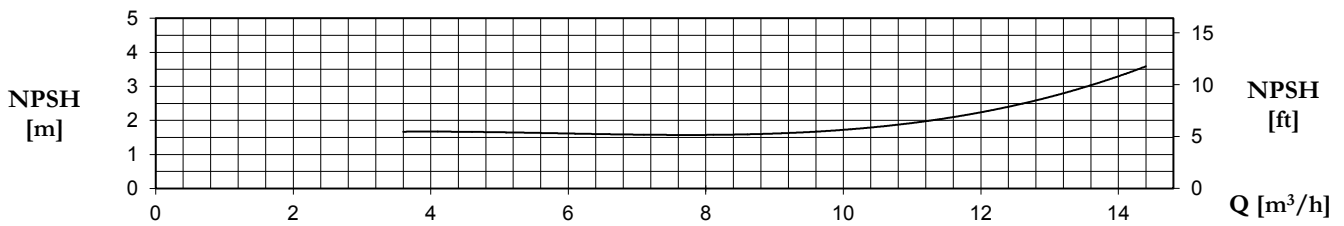
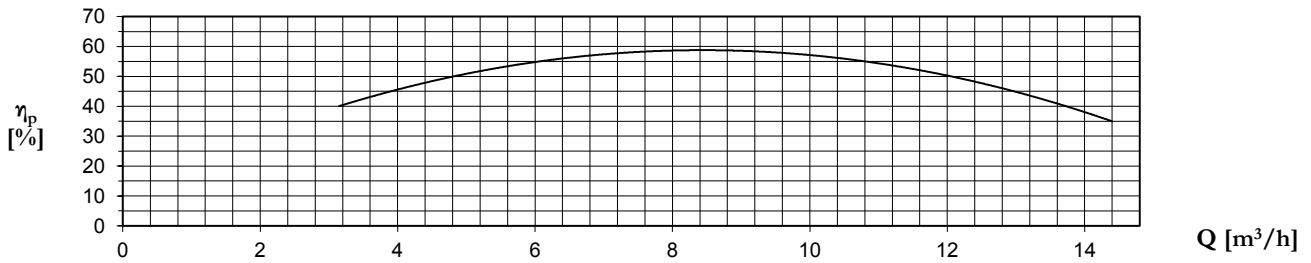
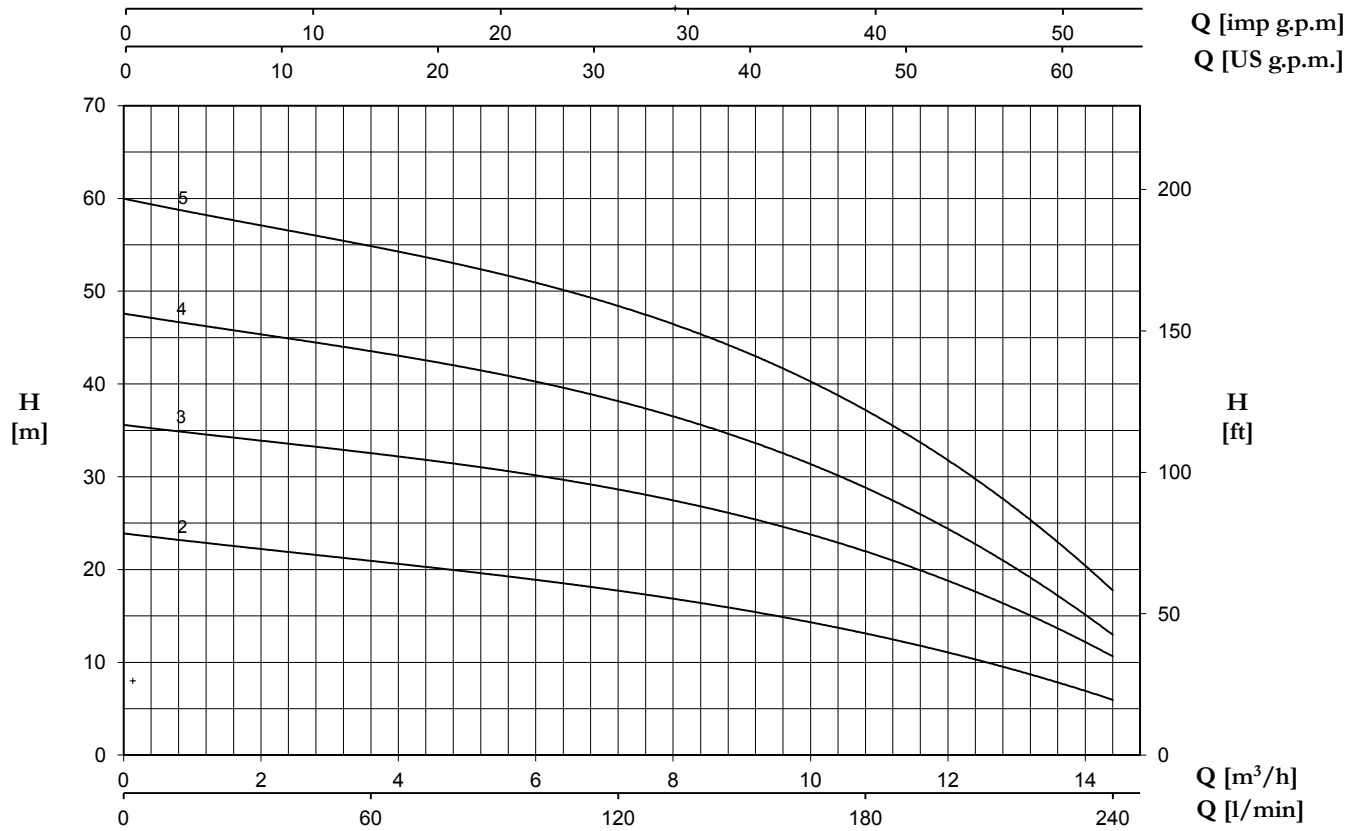

TYPE		P2		P1 (kW)		AMPERE		Q (m³/h - l/min)										
1~	3~					1~	3~	0	3,6	4,8	6	7,2	8,4	9,6	10,8	12	13,2	14,4
		(HP)	(kW)	1~	3~	1x230 V 50 Hz	3x400 V 50 Hz	H (m)										
U 9S-100/2	U 9S-100/2T	1	0,75	0,99	0,95	4,5	1,6	23,9	20,9	20	18,8	17,7	16,5	15	13	11	8,7	6
U 9S-150/3	U 9S-150/3T	1,5	1,1	1,47	1,4	6,8	2,8	35,6	32,5	31,5	30	28,7	26,9	24,6	22	18,7	15	10,7
U 9S-200/4	U 9S-200/4T	2	1,5	1,88	1,77	8,4	3,3	47,6	43,5	42,1	40,1	38,1	35,7	32,7	28,9	24,2	19	13,1
U 9S-250/5	U 9S-250/5T	2,5	1,85	2,36	2,23	10,8	4,3	60	54,8	53	51	48,2	45,4	42	37,3	31,6	25	18

ULTRA S

18 S

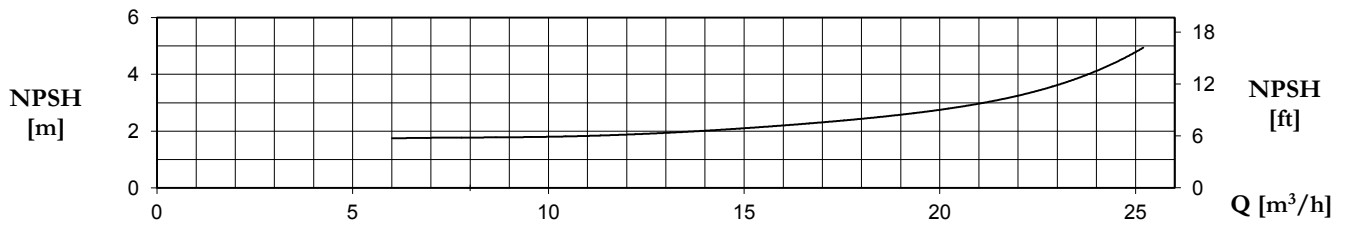
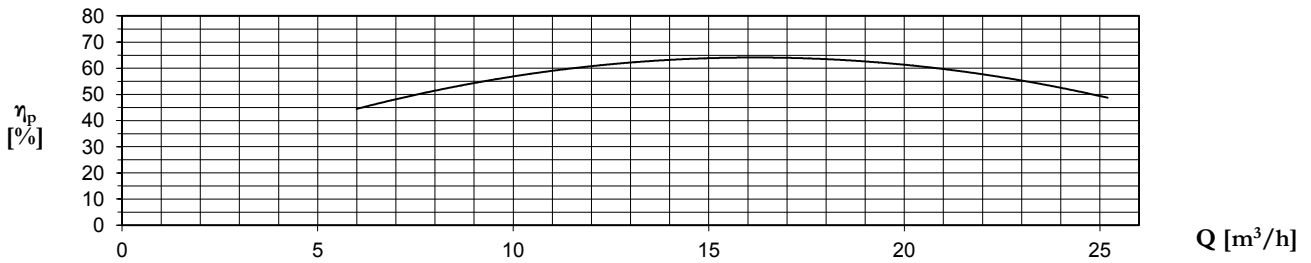
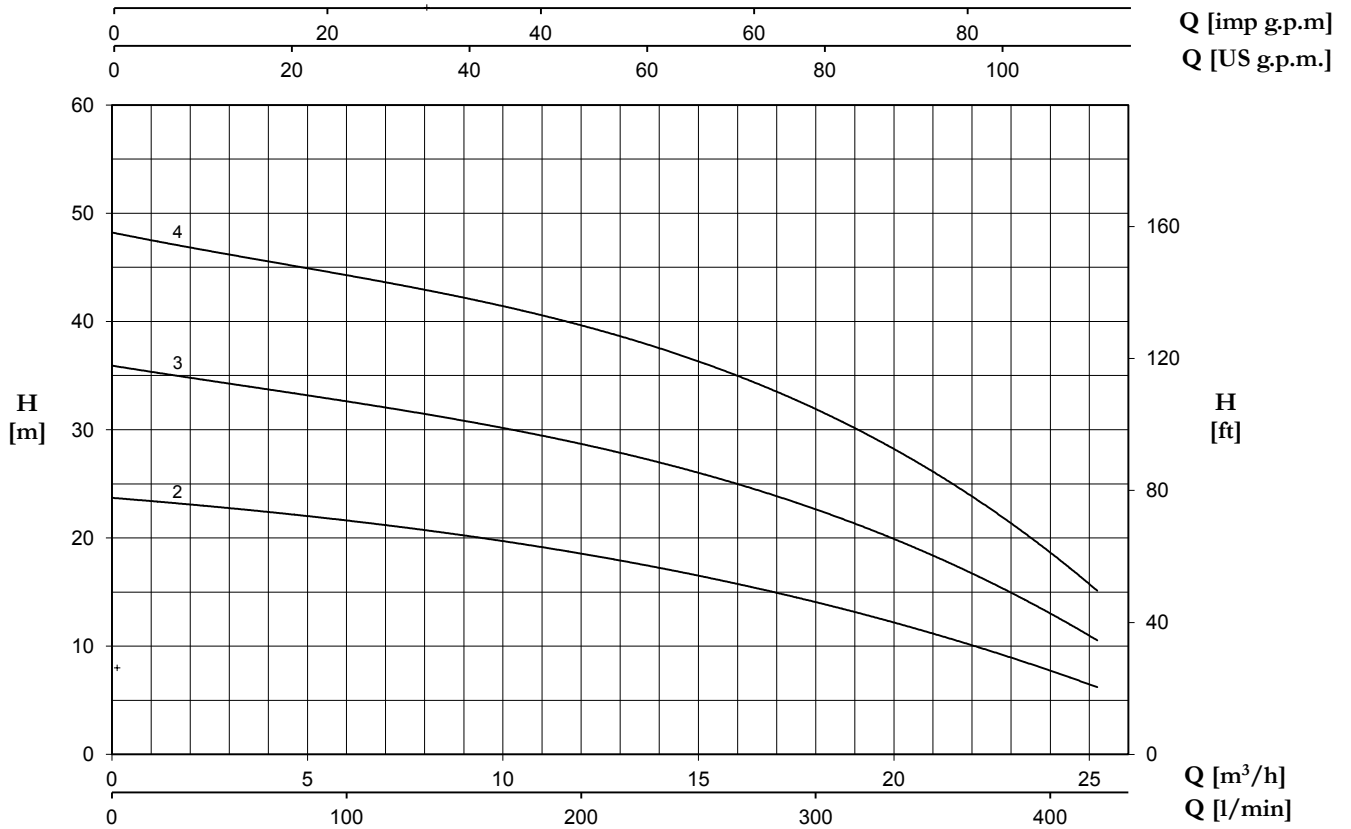

TYPE	P2		P1 (kW)	Q (m³/h - l/min)																		
				AMPERE	H (m)																	
					3~	0	6	7,2	8,4	9,6	10,8	12	13,2	14,4	15,6	16,8	18	19,2	20,4	21,6	22,8	24
3~	(HP)	(kW)	3~	3x400 V	50 Hz																	
U 18S-180/2T	1,8	1,3	1,59	3	23,7	21,7	21,1	20,4	20	19,3	18,5	17,7	16,9	16	15,2	14,3	13,1	11,8	10,3	9,1	7,6	6,4
U 18S-250/3T	2,5	1,85	2,29	4,4	35,7	33,1	32,3	31,3	30,4	29,4	28,4	27,4	26,3	25,1	24	22,8	21,4	19,6	17,8	15,4	12,9	10,2
U 18S-400/4T	4	3	3,11	5,7	47,9	45	44	42,8	41,7	40,5	39,1	37,8	36,6	35,2	33,9	32,2	30,2	28	25,1	22,1	18,1	14,9

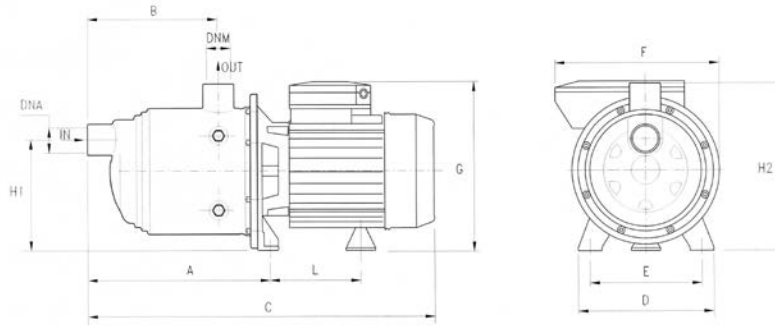

TYPE	DIMENSIONS (mm)										Kg	DNA	DNM
	A	B	C	D	E	F	G	L	H1	H2			
U 3S-50/2	166.8	103	333	164	140	178	190	93.7	128	192	7	1" G	1" G
U 3S-70/3	166.8	103	333	164	140	178	190	93.7	128	192	8		
U 3S-90/4	190.8	127	357	164	140	178	190	93.7	128	192	9,5		
U 3S-100/5	214.8	151	404	164	140	178	203	104.7	128	192	12		
U 3S-120/6	238.8	175	428	164	140	178	203	104.7	128	192	13		
U 3S-150/7	262.8	199	483	164	140	201	211	128.2	134	198	16		
U 5S-70/2	166.8	103	333	164	140	178	195	93.7	128	192	7,5		
U 5S-80/3	166.8	103	357	164	140	178	203	93.7	128	192	10		
U 5S-120/4	190.8	127	380	164	140	178	203	104.7	128	192	12		
U 5S-150/5	214.8	151	436	164	140	201	211	128.2	134	198	15		
U 5S-180/6	238.8	175	459	164	140	201	211	128.2	134	198	16,5		
U 5S-200/7	262.8	199	483	164	140	201	211	128.2	134	198	17,5		

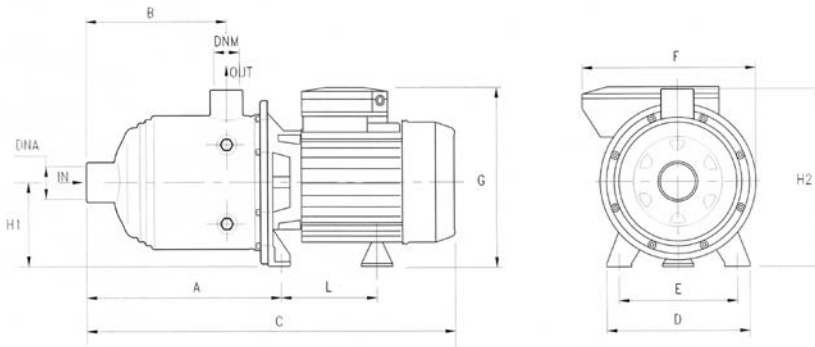

TYPE	DIMENSIONS (mm)										Kg	DNA	DNM
	A	B	C	D	E	F	G	L	H1	H2			
U 7S-100/2	166.8	103	356	164	140	178	203	104.7	103	192	10,5	1" 1/4 G	1" G
U 7S-120/3	166.8	103	356	164	140	178	203	104.7	92	192	11,5		
U 7S-180/4	190.8	127	411	164	140	201	211	128.2	98	198	15		
U 7S-250/5	214.8	151	436	164	140	201	211	128.2	98	198	17,5		
U 7S-300/6	238.8	175	M 503 T 459	164	140	201	M 229 T 211	M 148.2 T 128.2	M 103 T 98	M 203 T 198	M 19,5 T 18		
U 7S-350/7	262.8	199	527	164	140	201	229	148.2	92	203	20		
U 9S-100/2	185.8	118	375	164	140	178	203	104.7	98	192	10,5	1" 1/2 G	1" 1/4 G
U 9S-150/3	185.8	118	375	164	140	201	211	128.2	98	198	14		
U 9S-200/4	215.8	148	436	164	140	201	211	128.2	98	198	16		
U 9S-250/5	245.8	178	464	164	140	201	211	128.2	98	198	18		
U 18S-180/2T	201	141	432	164	140	201	211	128.2	98	198	14	2" G	1" 1/2 G
U 18S-250/3T	238.5	141	432	164	140	201	211	128.2	98	198	16		
U 18S-400/4T	276	178.5	514	164	140	201	229	148,2	103	203	22		

TYPE	TRUCK		CONTAINER	
	PALLET (cm)	N° pumps	PALLET (cm)	N° pumps
U 3S-50/2-90/4	80X120X150	84	80X120X175	96
U 3S-100/5-120/6	85X110X160	70	85X110X185	80
U 3S-150/7	80X120X150	42	80X120X175	49
U 5S-70/2	80X120X150	84	80X120X175	96
U 5S-80/3-120/4	85X110X160	70	85X110X185	80
U 5S-150/5	90X110X150	54	90X110X170	63
U 5S-180/6-200/7	80X120X150	42	80X120X175	49
U 7S-100/2-120/3	85X110X160	70	85X110X185	80
U 7S-180/4-250/5	90X110X150	54	90X110X170	63
U 7S-300/6T	80X120X150	42	80X120X175	49
U 7S-300/6 M-350/7T	80X120X145	35	80X120X170	42
U 9S-100/2	85X110X160	70	85X110X185	80
U 9S-150/3-200/4	90X110X150	54	90X110X170	63
U 9S-250/5	80X120X150	42	80X120X175	49
U 18S-180/2-250/3	90X110X150	54	90X110X170	63
U 18S-400/4	80X120X145	35	80X120X170	42